

# Content

1. Safety Instruction .....	2
2. Product general introduction .....	3
3. Read before first use .....	3
4. Setting Function .....	13
5. Cup warmer function.....	25
6. Clean function.....	25
7. Powder thickness adjustment.....	26
8. Disassembly process and cleaning method of external parts of the machine.....	27
9. Warning icon and solutions .....	29
10. Main Specifications .....	<u>32</u>

This is a watermark for the trial version, register to get the full one!

Benefits for registered users:

- 1.No watermark on the output documents.
- 2.Can operate scanned PDF files via OCR.
- 3.No page quantity limitations for converted PDF files.

**Remove Watermark Now**

# 1. Safety Instruction

- (1) Read and preserve the instruction manual carefully.
- (2) Keep the machine on a stable desktop, which is dry, ventilated and out of the reach of children.
- (3) Understand the power specification before using the machine, and connect the power according to the requirement.
- (4) Don't use the machine when it is under water shortage.
- (5) Dispose the plastic and bubble board in the package appropriately to avoid hurting children.
- (6) Please don't use the machine in outdoors.
- (7) Please keep the machine far from heat producer, avoid the damaging to the surface of machine.
- (8) Normal environment temperature for use and storage is 0°C~+45°C, frozen may damage the machine.

(9) Please add home temperature water in water container, hot water will damage the machine.

This is a watermark for the trial version, register to get the full one!

(11) Don't change technical situation of the machine, which will cause serious harm,

Benefits for registered users:

- 1.No watermark on the output documents.
- 2.Can operate scanned PDF files via OCR.
- 3.No page quantity limitations for converted PDF files.

**Remove Watermark Now**

(14) The machine is not applicable to the group deficiency in physical, feelings and mental, including children, except they are under the direction of guardian to operate the machine safely.

(15) Please take care to avoid the entrance of water inside the machine and touch to the electrical parts, it will cause short circuit.

(16) If you will not use the machine for a long period, please power off and disconnect the plug.

(17) Should you have any questions on the machine, Please kindly contact us by service hotline.

## 2. Product general introduction

The machine can use roasted coffee beans to drinks like Espresso, Americano, Cappuccino, and use chocolate powder to make hot chocolate, milk chocolate, latte macchiato and so on.

## 3. Read before first use

In order to be safty to you and others, please read the instruction manual first.

The original package can keep the machine to aviod the damage during transportation, we suggest you to keep the package, so you can use for future transportation.

- (1) Take the coffee machine out from the package, and put on a stable desktop
- (2) Put the drip tray on right position of the machine.
- (3) Add water into water container, and make sure the water level higher than the water level floater
- (4) Add more than 30g coffee beans into the bean container for first use, only coffee

beans can be placed in the bean container, please don't add water, coffee power, coffee beans mixed with stones and other hard objects, otherwise the grinder will be damaged.

This is a watermark for the trial version, register to get the full one!

Benefits for registered users:

- 1.No watermark on the output documents.
- 2.Can operate scanned PDF files via OCR.
- 3.No page quantity limitations for converted PDF files.

**Remove Watermark Now**

Press the icon  in setting menu, the screen will show milk clean interface, put the milk tube into clean water, and press "OK" to clean the milk system;



**Remarks:** If the milk system was not cleaned for a long time, the remaining milk inside the milk system will caking and block the milk system, which will reduce working like of milk system.

### 3.1 Introduction of components

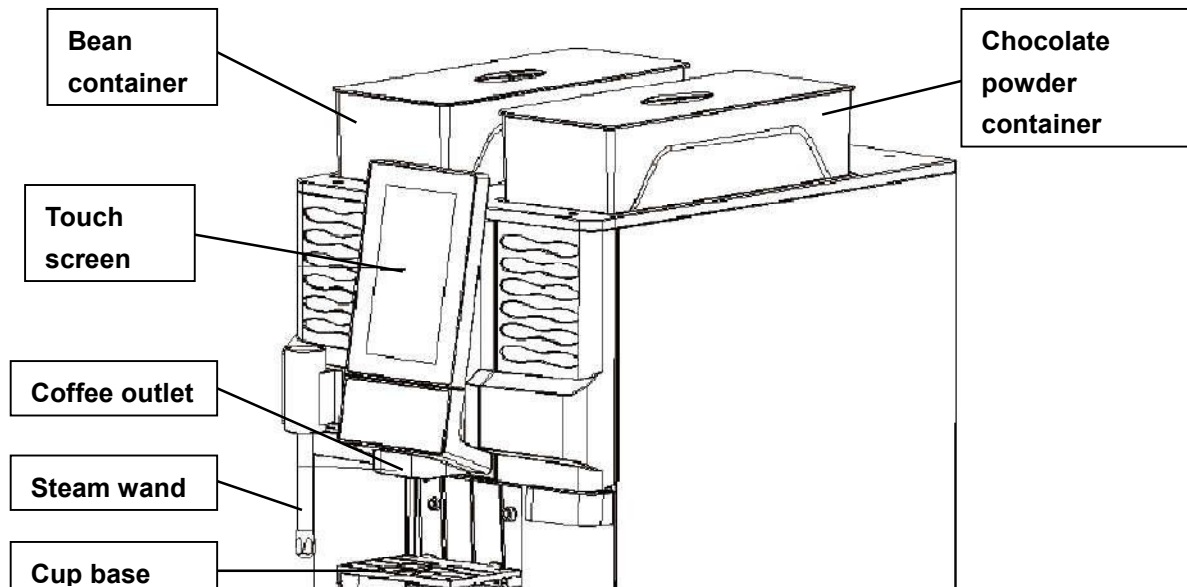

This is a watermark for the trial version, register to get the full one!

Benefits for registered users:

- 1.No watermark on the output documents.
- 2.Can operate scanned PDF files via OCR.
- 3.No page quantity limitations for converted PDF files.

[Remove Watermark Now](#)

### 3.3 Preparation before use the machine

- (1) Prepare the machine according to "ready before first use"
- (2) the machine will be waken up, start self-test, heating and self-clean process, please don't operate the machine during above processes.
- (3) After the self-cleaning, the machine will enter the main function interface,



Self-Testing



Main function interface

### 3.4 Espresso Making

This is a watermark for the trial version, register to get the full one!

(1) Press the espresso function icon , and the machine will start to make espresso.

Benefits for registered users:

- 1.No watermark on the output documents.
- 2.Can operate scanned PDF files via OCR.
- 3.No page quantity limitations for converted PDF files.

[Remove Watermark Now](#)



(2) During the espresso process, users can also press the icon  to stop the process any time.

(3) After finish the espresso brew process, the touch screen will back to main function interface, and users can enjoy the drink. After all coffee brewing process, the brewing unit will return to it's original position automatically, please operate the coffee machine after this process.

### 3.5 Americano Making

(1) Press the americano function icon , and the machine will start to make Americano.



This is a watermark for the trial version, register to get the full one!

(2) During the americano process, users can also press the icon  to stop the process any time.

- Benefits for registered users:
- 1.No watermark on the output documents.
  - 2.Can operate scanned PDF files via OCR.
  - 3.No page quantity limitations for converted PDF files.

[Remove Watermark Now](#)

### 3.6 Cappuccino Making

(1) Press the cappuccino function icon , and the machine will start to make cappuccino.



(2) During the cappuccino process, users can also press the icon  to stop the process any time.

(3) After finish the cappuccino brew process, the touch screen will back to main screen. After this process, the coffee brewing unit will return to it's original position automatically, please operate the coffee machine after this process.

This is a watermark for the trial version, register to get the full one!

Benefits for registered users:

- 1.No watermark on the output documents.
- 2.Can operate scanned PDF files via OCR.
- 3.No page quantity limitations for converted PDF files.

[Remove Watermark Now](#)



(2) During the Latte process, users can also press the icon  to stop the process

any time.

(3) After finish the Latte brew process, the touch screen will back to main function interface, and users can enjoy the drink. After all coffee brewing process, the brewing unit will return to it's original position automatically, please operate the coffee machine after this process.

### 3.8 Moka Making

(1) Press the moka function icon  , and the machine will start to make moka.

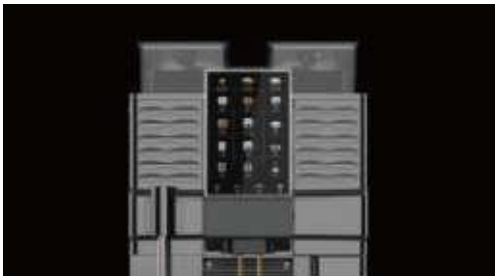

This is a watermark for the trial version, register to get the full one!

Benefits for registered users:

- 1.No watermark on the output documents.
- 2.Can operate scanned PDF files via OCR.
- 3.No page quantity limitations for converted PDF files.

[Remove Watermark Now](#)

(2) During the moka process, users can also press the icon  to stop the process

any time.

(3) After finish the moka brew process, the touch screen will back to main function interface, and users can enjoy the drink. After all coffee brewing process, the brewing unit will return to it's original position automatically, please operate the coffee machine after this process.

### 3.9 Macchiato Making

(1) Press the macchiato function icon  , and the machine will start to make macchiato.





(2) During the macchiato process, users can also press the icon  to stop the process any time.

(3) After finish the macchiato brew process, the touch screen will back to main screen. After the coffee is brewed, the brewing unit will return to it's original position automatically, please operate the coffee machine after this process.

This is a watermark for the trial version, register to get the full one!

Benefits for registered users:

- 1.No watermark on the output documents.
- 2.Can operate scanned PDF files via OCR.
- 3.No page quantity limitations for converted PDF files.

[Remove Watermark Now](#)



(2) During the hot chocolate process, users can also press the icon  to stop the

process any time.

(3) After finish the hot chocolate brew process, the touch screen will back to main function interface, and users can enjoy the drink. After all coffee brewing process, the brewing unit will return to it's original position automatically, please operate the coffee machine after this process.

### 3.11 Milk Chocolate Making

(1) Press the milk chocolate function icon  , and the machine will start to make milk chocolate.



This is a watermark for the trial version, register to get the full one!

Benefits for registered users:

- 1.No watermark on the output documents.
- 2.Can operate scanned PDF files via OCR.
- 3.No page quantity limitations for converted PDF files.

[Remove Watermark Now](#)

(2) During the milk chocolate process, users can also press the icon  to stop the process any time.

(3) After finish the milk chocolate brew process, the touch screen will back to main function interface, and users can enjoy the drink. After all coffee brewing process, the brewing unit will return to it's original position automatically, please operate the coffee machine after this process.

### 3.12 Milk Foam Making

(1) Press the milk foam function icon  , and the machine will start to make milk foam.



(2) During the milk foam process, users can also press the icon  to stop the process any time.

(3) After finish the milk foam brew process, the touch screen will back to main screen. After the coffee is brewed, the brewing unit will return to its original position automatically, please operate the coffee machine after this process.

This is a watermark for the trial version, register to get the full one!

Benefits for registered users:

- 1.No watermark on the output documents.
- 2.Can operate scanned PDF files via OCR.
- 3.No page quantity limitations for converted PDF files.

[Remove Watermark Now](#)

(1) Press the hot milk function icon , and the machine will start to make hot milk.



(2) During the hot milk process, users can also press the icon  to stop the

process any time.

(3) After finish the hot milk brew process, the touch screen will back to main function interface, and users can enjoy the drink. After all coffee brewing process, the brewing unit will return to it's original position automatically, please operate the coffee machine after this process.

### 3.14 Steam Making



(1) Press the steam function icon  , the steam wand will start to produce steam, please don't touch the steam wand directly during this process, the high temperature on the surface of steam wand might cause scald.



This is a watermark for the trial version, register to get the full one!

Benefits for registered users:

- 1.No watermark on the output documents.
- 2.Can operate scanned PDF files via OCR.
- 3.No page quantity limitations for converted PDF files.

[Remove Watermark Now](#)

(2) During the steam process, users can also press the icon  to stop the process any time.

(3) After finish the steam process, the touch screen will back to main function interface, it means the steam process finish.

### 3.15 Hot Water Making



(1) Press the hot water function icon  , and the machine will start to make hot water.



(2) During the hot water process, users can also press the icon  to stop the process any time.

(3) After finish the hot water process, the touch screen will back to main function

This is a watermark for the trial version, register to get the full one!

Benefits for registered users:

- 1.No watermark on the output documents.
- 2.Can operate scanned PDF files via OCR.
- 3.No page quantity limitations for converted PDF files.

[Remove Watermark Now](#)

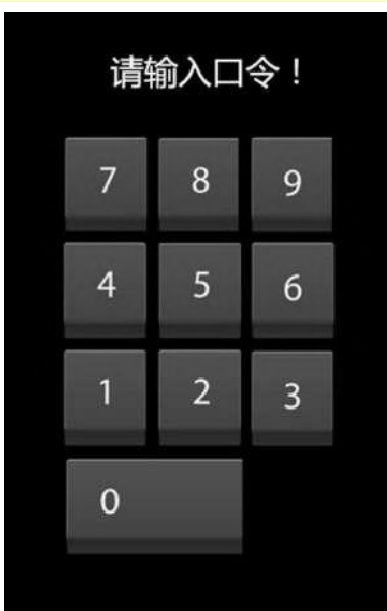

## 4.1 Coffee Temperature



Press icon , the display will show temperature adjust interface, please choose your required temperature, and press "OK" to confirm your selection. (Remarks: the hot water temperature adjustment is from 70-95°C)



This is a watermark for the trial version, register to get the full one!

Benefits for registered users:

- 1.No watermark on the output documents.
- 2.Can operate scanned PDF files via OCR.
- 3.No page quantity limitations for converted PDF files.

[Remove Watermark Now](#)

Press icon , the display shows the total cups of each drink made by coffee machine.



### 4.3 "Favorite" in "Setting Menu Up" before coffee making



Please press "Favorite" icon, the screen show favorite taste adjustment function as following.



This is a watermark for the trial version, register to get the full one!

4.3.1 Press espresso icon, users can adjust the espresso volume and coffee powder volume, and press "OK" icon to confirm. (Remarks: the espresso volume is adjustable from 20-25 ml, and the coffee powder volume is adjustable from 5-16g)

- Benefits for registered users:
- 1.No watermark on the output documents.
  - 2.Can operate scanned PDF files via OCR.
  - 3.No page quantity limitations for converted PDF files.

**Remove Watermark Now**



4.3.2 Press americano icon, users can adjust the americano volume and coffee powder volume, and press "OK" icon to confirm. (Remarks: the americano volume is adjustable from 20-250ml, and the coffee powder volume is adjustable from 5-16g)



**4.3.3** Press cappuccino icon, users can adjust the cappuccino volume, coffee powder volume, milk time, and press "OK" icon to confirm. (Remarks: the cappuccino volume is adjustable from 20-250ml, and the coffee powder volume is adjustable from 5-16g, and milk time is adjustable from 10-100 seconds)

This is a watermark for the trial version, register to get the full one!

Benefits for registered users:

- 1.No watermark on the output documents.
- 2.Can operate scanned PDF files via OCR.
- 3.No page quantity limitations for converted PDF files.

**Remove Watermark Now**

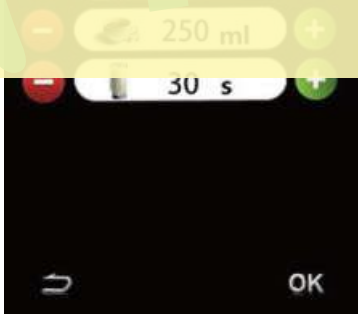

**4.3.4** Press latte icon, users can adjust the latte volume, coffee powder volume, milk time, and press "OK" icon to confirm. (Remarks: the latte volume is adjustable from 20-250ml, and the coffee powder volume is adjustable from 5-16g, and milk time is adjustable from 10-100 seconds)





4.3.5 Press latte icon, users can adjust the moka volume, coffee powder volume, hot chocolate volume, chocolate powder volume, and press "OK" icon to confirm.

(Remarks: the moka volume is adjustable from 20-250ml, and the coffee powder volume is adjustable from 5-16g, hot chocolate volume is adjustable from 60-250ml, chocolate powder volume is adjustable from 10-100g, and milk time is adjustable from 10-100 seconds)

This is a watermark for the trial version, register to get the full one!

Benefits for registered users:

1. No watermark on the output documents.
2. Can operate scanned PDF files via OCR.
3. No page quantity limitations for converted PDF files.

[Remove Watermark Now](#)

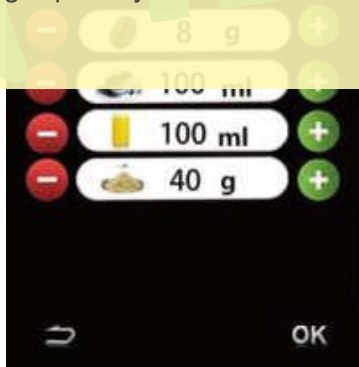

4.3.6 Press macchiato icon, users can adjust the macchiato volume, coffee powder volume, hot chocolate volume, chocolate powder volume, milk time, and press "OK" icon to confirm. (Remarks: the moka volume is adjustable from 20-250ml, and the coffee powder volume is adjustable from 5-16g, hot chocolate volume is adjustable from 60-250ml, chocolate powder volume is adjustable from 10-100g, and milk time is adjustable from 10-100 seconds)



**4.3.7 Press hot chocolate icon, users can adjust the hot chocolate volume, chocolate powder volume, and press "OK" icon to confirm. (Remarks: hot chocolate volume is adjustable from 60-250ml, chocolate powder volume is adjustable from 10-100g)**

This is a watermark for the trial version, register to get the full one!

Benefits for registered users:

- 1.No watermark on the output documents.
- 2.Can operate scanned PDF files via OCR.
- 3.No page quantity limitations for converted PDF files.

**Remove Watermark Now**

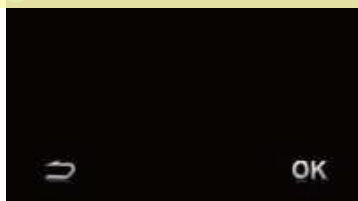

**4.3.8 Press milk chocolate icon, users can adjust the hot chocolate volume, chocolate powder volume, milk time, and press "OK" icon to confirm. (Remarks: hot chocolate volume is adjustable from 60-250ml, chocolate powder volume is adjustable from 10-100g, and milk time is adjustable from 10-100 seconds)**

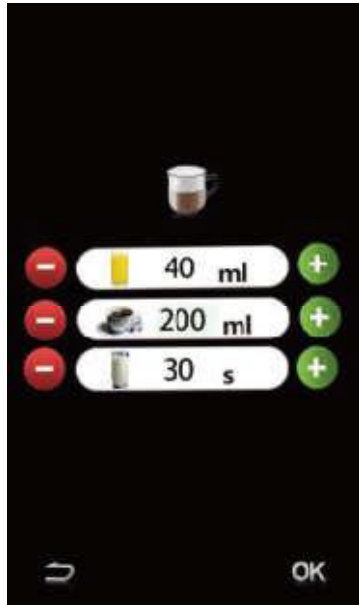

**4.3.9 Press milk foam icon, users can adjust the milk foam time, and press "OK" icon to confirm. (Remarks: the milk foam time is adjustable from 10-100s)**

This is a watermark for the trial version, register to get the full one!

Benefits for registered users:

- 1.No watermark on the output documents.
- 2.Can operate scanned PDF files via OCR.
- 3.No page quantity limitations for converted PDF files.

**Remove Watermark Now**

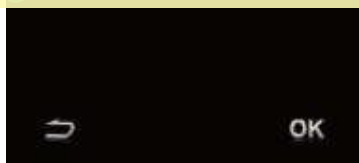

**4.3.10 Press hot milk icon, users can adjust the hot milk time, and press "OK" icon to confirm. (Remarks: the hot milk time is adjustable from 10-100s)**



**4.3.11 Press steam icon, users can adjust the steam time, and press "OK" icon to confirm. (Remarks: the steam time is adjustable from 10-100s)**

This is a watermark for the trial version, register to get the full one!

Benefits for registered users:

- 1.No watermark on the output documents.
- 2.Can operate scanned PDF files via OCR.
- 3.No page quantity limitations for converted PDF files.

**Remove Watermark Now**

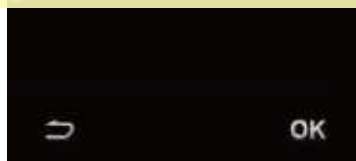

**4.3.12 Press hot water icon, users can adjust the hot water volume, and press "OK" icon to confirm. (Remarks: the hot water volume is adjustable from 60-300ml)**

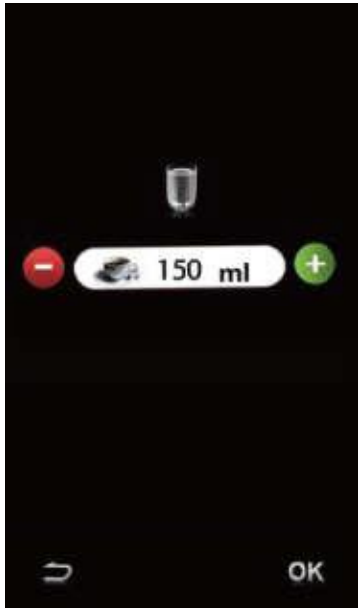

#### 4.4 Language Setting

This is a watermark for the trial version, register to get the full one!

Press the language icon  , the screen will show 8 languages for select: CHN, ENG, KOR, GER, RUS, FRA, ITA, ESP. select the required language and press "OK" to confirm.

Benefits for registered users:

- 1.No watermark on the output documents.
- 2.Can operate scanned PDF files via OCR.
- 3.No page quantity limitations for converted PDF files.

[Remove Watermark Now](#)



#### 4.5 Factory Reset

Press the reset icon  ,the screen will show factory reset interface, press "ok" icon to reset.



## 4.6 System Setting

Press the System settings icon , can change existing settings and choose different coffee profiles to suit your taste. Press the OK key to confirm.

This is a watermark for the trial version, register to get the full one!

Benefits for registered users:

- 1.No watermark on the output documents.
- 2.Can operate scanned PDF files via OCR.
- 3.No page quantity limitations for converted PDF files.

[Remove Watermark Now](#)



## 4.7 Boiler Empty

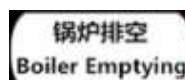

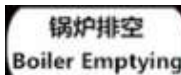
Press the set interface icon  function. The hot water in the coffee machine boiler can be completely discharged to the drip tray. Before emptying, please empty the drip tray. The screen shows that the emptying has been completed, and the machine can be turned off.



## 4.8. Self-clean setting

Press the set interface icon , Set the time for self-cleaning in standby mode, and

This is a watermark for the trial version, register to get the full one!

Benefits for registered users:

- 1.No watermark on the output documents.
- 2.Can operate scanned PDF files via OCR.
- 3.No page quantity limitations for converted PDF files.

[Remove Watermark Now](#)

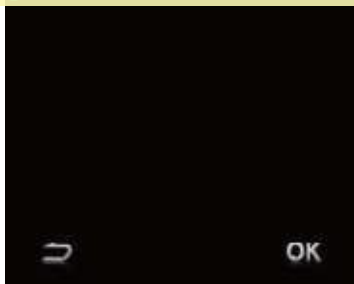

## 4.9 Eco time setting

Press the Set interface icon , Set the time for standby automatic turn off. If no operation is performed within the set time, the machine will automatically clean.  
(Remarks: time adjustment range is 0-600mins)

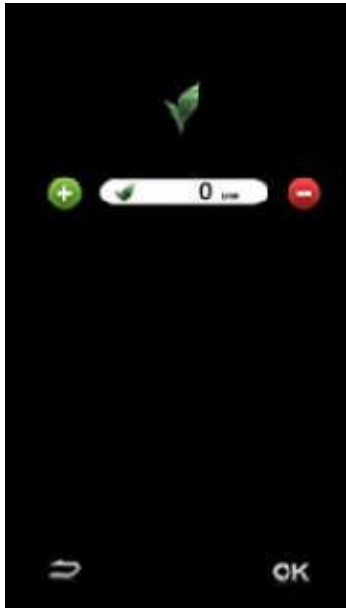

## 4.10 Descaling Setting

Press the descal icon , Descaling interface will appear, press "ok" icon, the descaling process is about 100 minutes, please follow the prompts to restart after descaling.

Benefits for registered users:

- 1.No watermark on the output documents.
- 2.Can operate scanned PDF files via OCR.
- 3.No page quantity limitations for converted PDF files.

[Remove Watermark Now](#)





## 5. Cup warmer function

Since each user's country is different from the region, or the cup temperature is different during use, in order to ensure the taste of the coffee, the cup can be heated before the coffee is made, so as to avoid different taste due to the difference in temperature.



This is a watermark for the trial version, register to get the full one!

Benefits for registered users:

- 1.No watermark on the output documents.
- 2.Can operate scanned PDF files via OCR.
- 3.No page quantity limitations for converted PDF files.

[Remove Watermark Now](#)



## 7. Powder thickness adjustment

1, Since each user's coffee beans are different in type or have different preferences, resulting in differences in the thickness of the coffee powder, the bean lid can be opened and the thickness of the powder can be adjusted according to one's preference.

1, The powder state is already fine, and can be adjusted in a small amount.

2. The coffee powder is thicker, you can press the adjustment knob, then turn the powder thickness knob.

(Remarks: Hot water volum adjustment range is 60-300ml )

This product has been set according to the factory's standard. The default is the finest position of the factory. If the user still needs to adjust, please use the small adjustment first. After setting, you need to brew 3 cups later to check the waste to confirm the thickness.

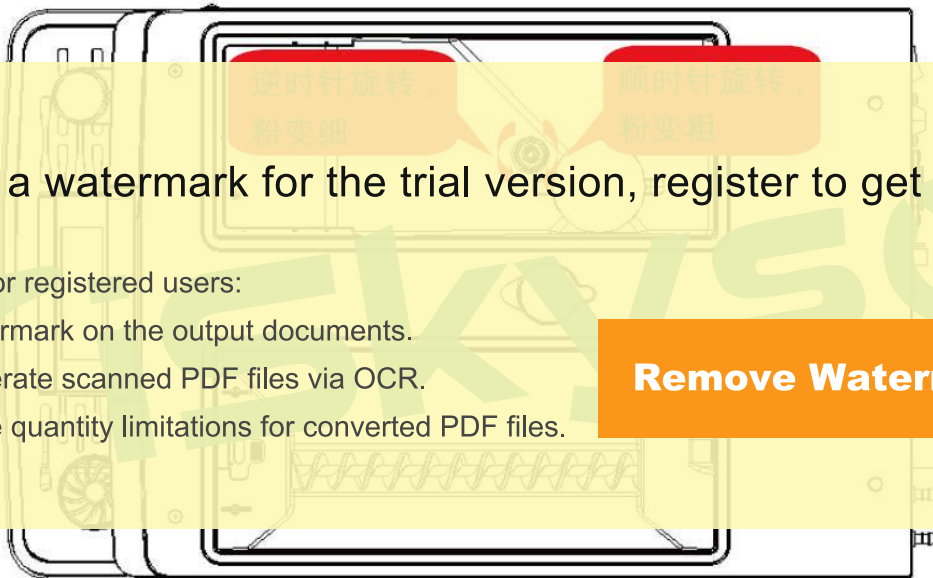

This is a watermark for the trial version, register to get the full one!

Benefits for registered users:

- 1.No watermark on the output documents.
- 2.Can operate scanned PDF files via OCR.
- 3.No page quantity limitations for converted PDF files.

[Remove Watermark Now](#)

## 8. Disassembly process and cleaning method of external parts of the machine

### 1, Disassembly and cleaning of the foamer assembly

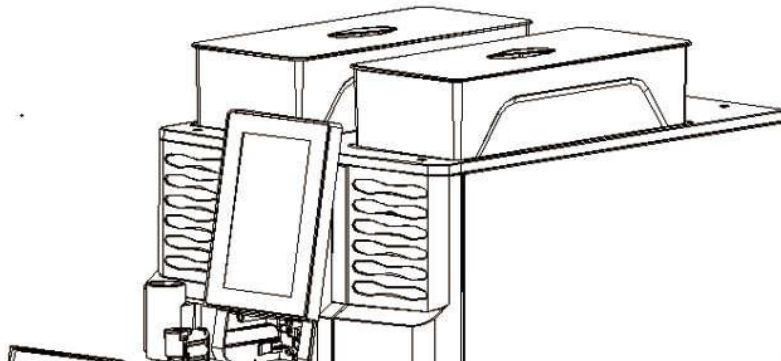

This is a watermark for the trial version, register to get the full one!

Benefits for registered users:

- 1.No watermark on the output documents.
- 2.Can operate scanned PDF files via OCR.
- 3.No page quantity limitations for converted PDF files.

[Remove Watermark Now](#)

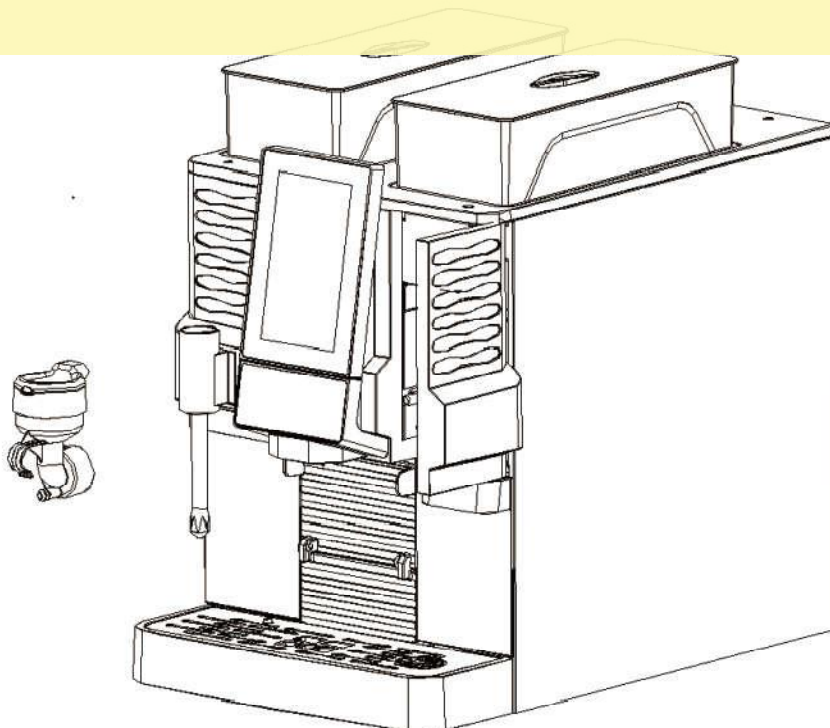

### 3. Disassembly and cleaning of Shrinking cup holder assembly

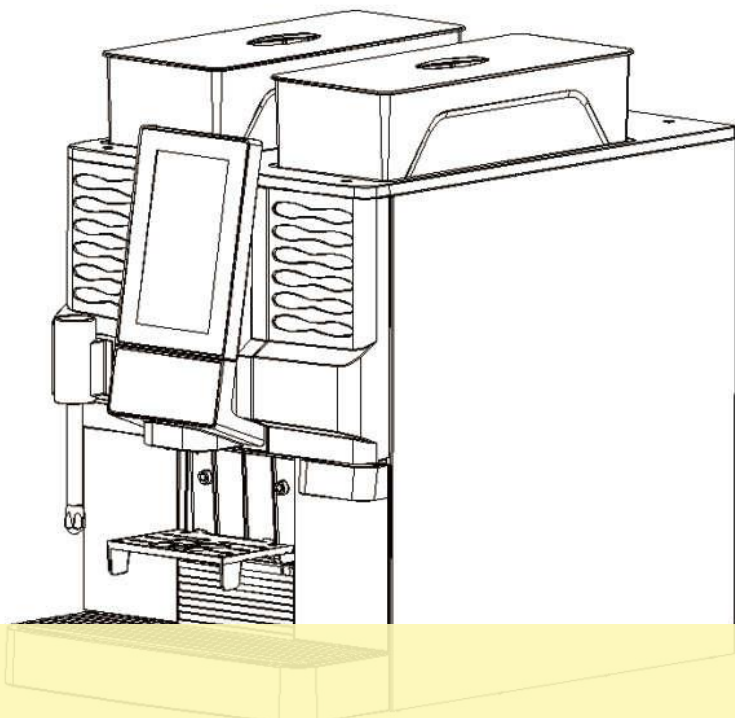

This is a watermark for the trial version, register to get the full one!

3. Disassembly and cleaning of the chocolate tank assembly

Benefits for registered users:

- 1.No watermark on the output documents.
- 2.Can operate scanned PDF files via OCR.
- 3.No page quantity limitations for converted PDF files.

**Remove Watermark Now**

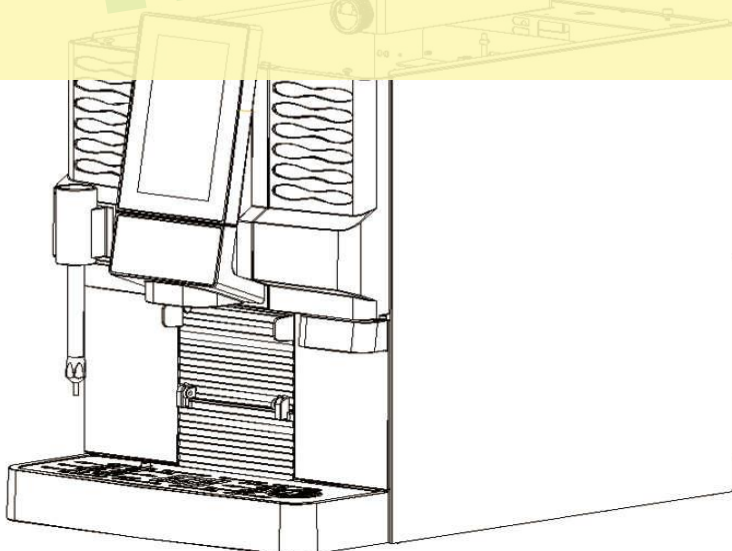

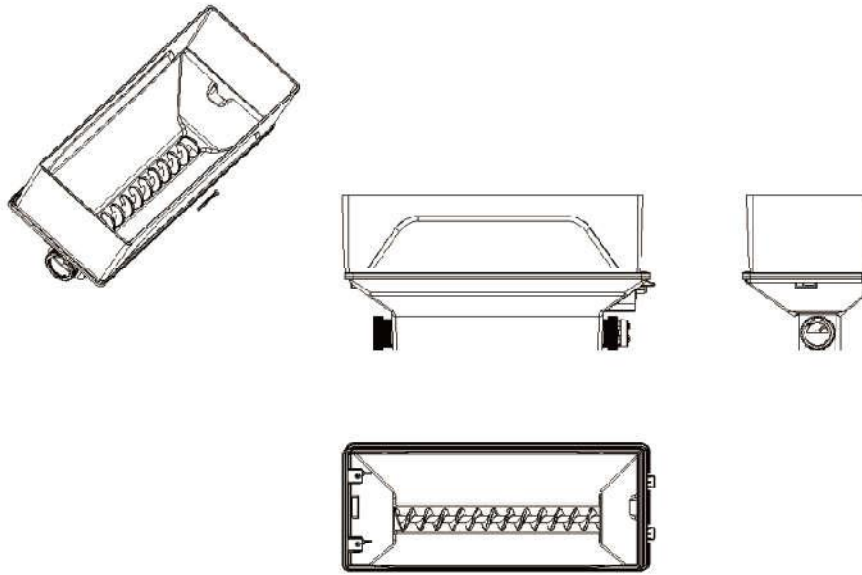



This is a watermark for the trial version, register to get the full one!

Benefits for registered users:

- 1.No watermark on the output documents.
- 2.Can operate scanned PDF files via OCR.
- 3.No page quantity limitations for converted PDF files.

**Remove Watermark Now**



2		Coffee outlet missing	Please put the coffee outlet in the correct position
3		Chocolate warehouse door is not closed	Closed the door



This is a watermark for the trial version, register to get the full one!

Benefits for registered users:

- 1.No watermark on the output documents.
- 2.Can operate scanned PDF files via OCR.
- 3.No page quantity limitations for converted PDF files.

**Remove Watermark Now**

			
--	---	--	--

5		Waster coffee container full	Please empty the waster coffee container
6		Tube Plugged	Check if the pipeline is blocked or bent, Please restar the machine

This is a watermark for the trial version, register to get the full one!

Benefits for registered users:

- 1.No watermark on the output documents.
- 2.Can operate scanned PDF files via OCR.
- 3.No page quantity limitations for converted PDF files.

**Remove Watermark Now**

tray in the correct  
position

			
--	---	--	--

# 10 Main Specifications

Main Specifications			
Voltage	220VAC	Power	2000W
WaterTank capacity	2400ml	Bean Tank capacity	450g
Coffee Volum	20-250ml	High bean tank capacity	1100g
ULKA Pump	19 Bar	Chocolate tank capacity	700g
Pre brewing	√	Higher chocolate tank capacity	2700g
Powder thickness adjustment	√	Drip tray capacity	650ml
Stainless steel	√	Product Weight	28kg
Espresso	√	Hot water	√
Cappuccino	√	Hot water	√
Latte	√	Hot water	√
Mocha	√	Movable water tank	√
Macchiato	√	Cup counter	√
Hot chocolate	√	Factory reset	√
Hot chocolate drink	√	Self-clean function	√
Milk foam	√	Component disassembly	√
Hot milk	√	favourite	√
Steam function	√	Setting adjustment	√

This is a watermark for the trial version, register to get the full one!

Benefits for registered users:

- 1.No watermark on the output documents.
- 2.Can operate scanned PDF files via OCR.
- 3.No page quantity limitations for converted PDF files.

**Remove Watermark Now**